

構成内容 / Components				
No.	名称 / Part name	数量 / Pcs	材質 / Material	色・表面処理 / Color・Finish
1	フレーム Frame	4	アルミ押出材 A6063S-T5 Extruded aluminium A6063S-T5	シルバーアルマイト, ブラックアルマイト Silver, Black・Anodized
2	コーナーブロック Corner block	4	ABS樹脂 UL94HB ABS UL94HB	ライトグレー, ブラック Light gray, Black
3	コーナーキャップ / Blind plug	8	エラストマ / TPE	ライトグレー, ブラック / Light gray, Black
4	ハメ込みパネル Slide panel	1	アルミ板 A1100P Aluminium A1100P	シルバーアルマイト, ブラック・塗装 Silver・Anodized, Black・Painted
5	ねじ止めパネル Screwed panel	1	アルミ板 A1100P Aluminium A1100P	シルバーアルマイト, ブラック・塗装 Silver・Anodized, Black・Painted
6	取付ビス (ナベ M4 x 15) Screw (Pan head M4 - 15)	16	鉄 Steel	三価クロメート Trivalent chromate
7	取付ビス (座付丸皿 M3 x 5) Screw (Slotted raised countersunk M3 - 5)	8	鉄 Steel	ニッケルメッキ, 三価黒クロメート Nickel plated, Black trivalent chromate

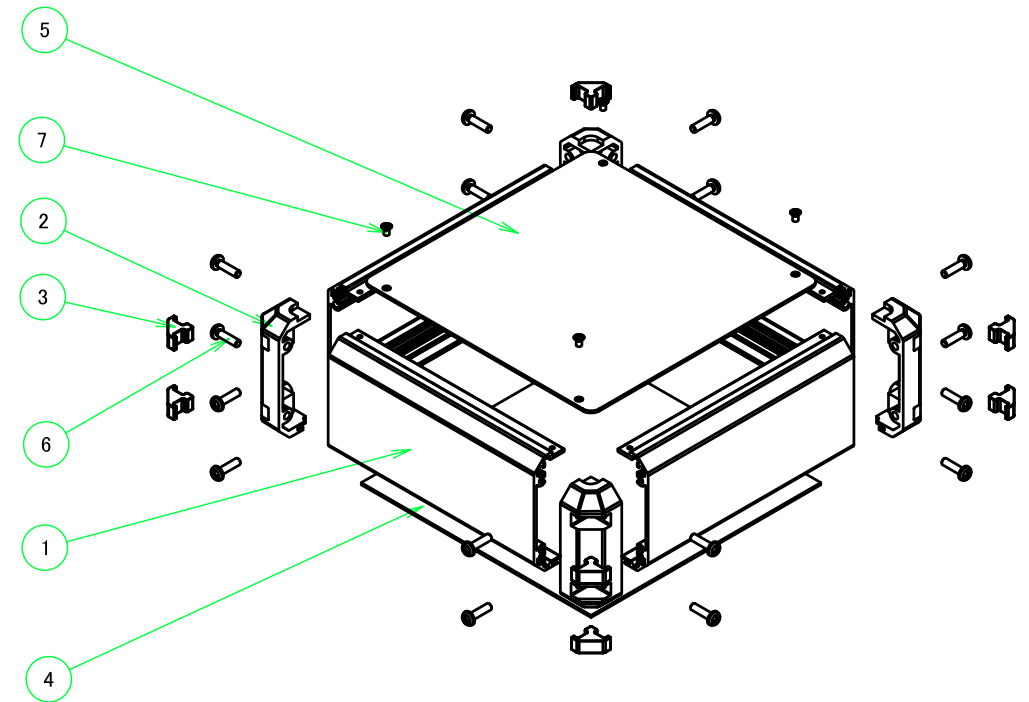

ケース型番 FCS
Product Number

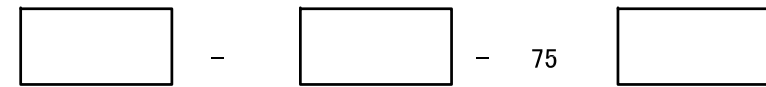

W

D

色記号
Color Code

Color Code

W, D 寸法制限範囲 / Dimension limit range	
W	D
601~1000	75~399

色仕様 (型番末尾□) / Color Type (End product number□)			
記号 / Code	パネル / Panel	フレーム / Frame	コーナー / Corner
GSS	シルバー / Silver	シルバー / Silver	ライトグレー / Light gray
BSS	シルバー / Silver	シルバー / Silver	ブラック / Black
BBS	シルバー / Silver	ブラック / Black	ブラック / Black
BBB	ブラック / Black	ブラック / Black	ブラック / Black

株式会社タカチ電機工業 TAKACHI ELECTRONICS ENCLOSURE CO., LTD.			品名 / Title フリーサイズボックス CUSTOM DIMENSIONS BOX	尺度 / Scale
承認 / Approved	検図 / Checked	製図 / Created	型番 / Product number FCS□-□-75□ (W601~1000mm, D75~399mm)	
中根	野村	中根	作成日 / Date 2019/12/23	1 / 7

フレーム1側 / Frame1 side



フレーム3側 / Frame3 side

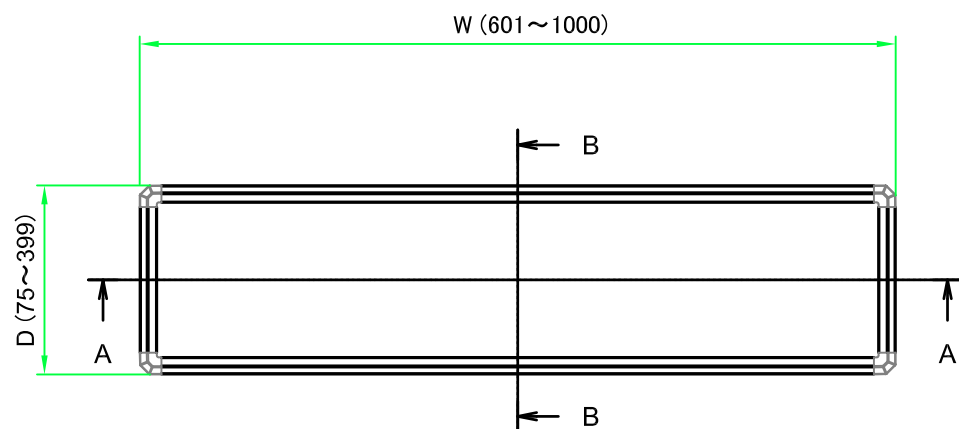
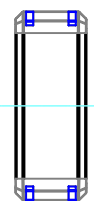

フレーム2側 / Frame2 side



A-A (1:8)

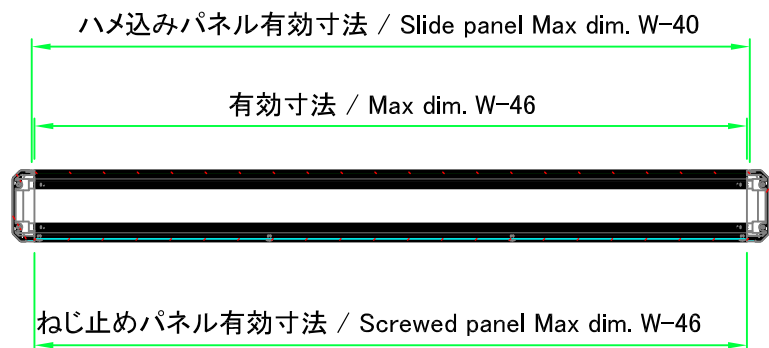

フレーム4側 / Frame4 side

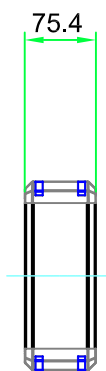

B-B (1:8)

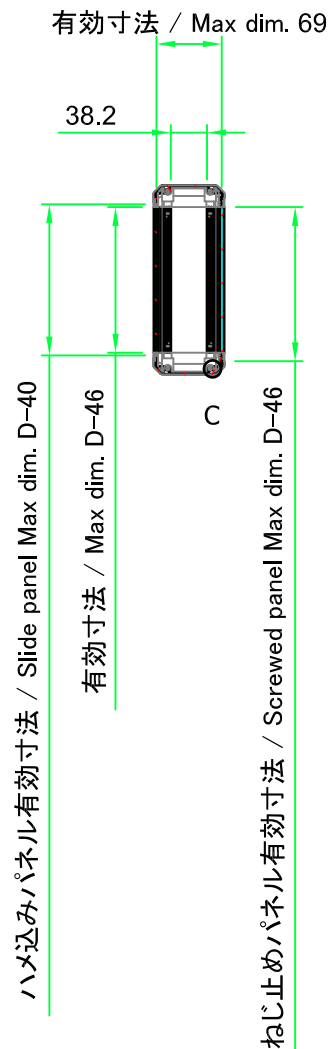

C : フレーム拡大図
Frame cross-section

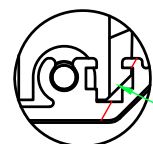

ナットレール / Nut rail

スライドナット用溝
別売りオプション品 スライドナット FZ-3 を入れる事が出来ます。
Groove for slide nut
Slide nut FZ-3 (sold separately as optional parts) can be inserted

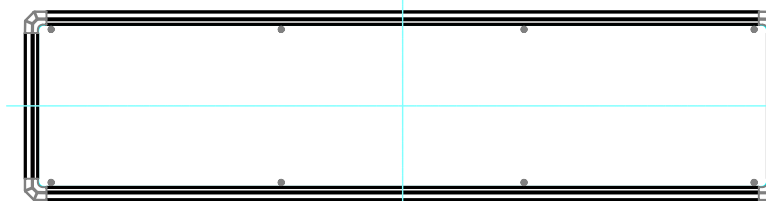

株式会社タカチ電機工業 TAKACHI ELECTRONICS ENCLOSURE CO., LTD.			品名/Title フリーサイズボックス CUSTOM DIMENSIONS BOX	尺度/Scale 1:8
承認/Approved 中根	検図/Checked 野村	製図/Created 中根	型番/Product number FCS□-□-75□ (W601~1000mm、D75~399mm)	
			作成日/Date 2019/12/23	2 / 7

W-46

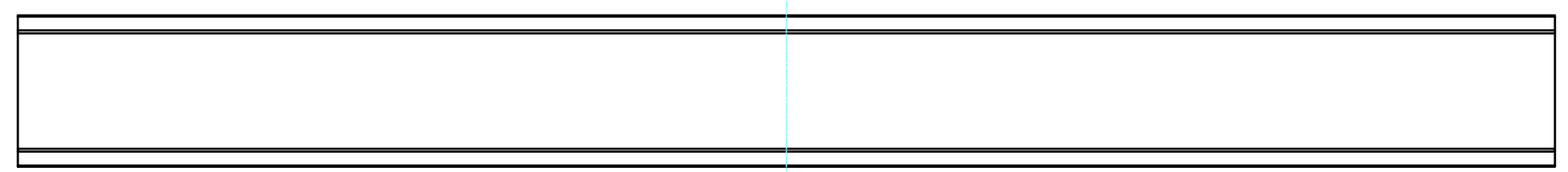
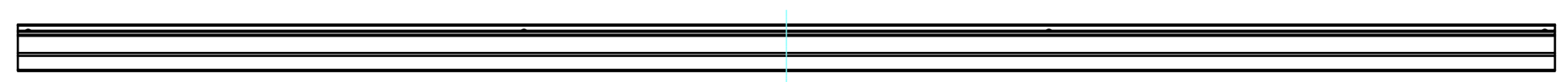
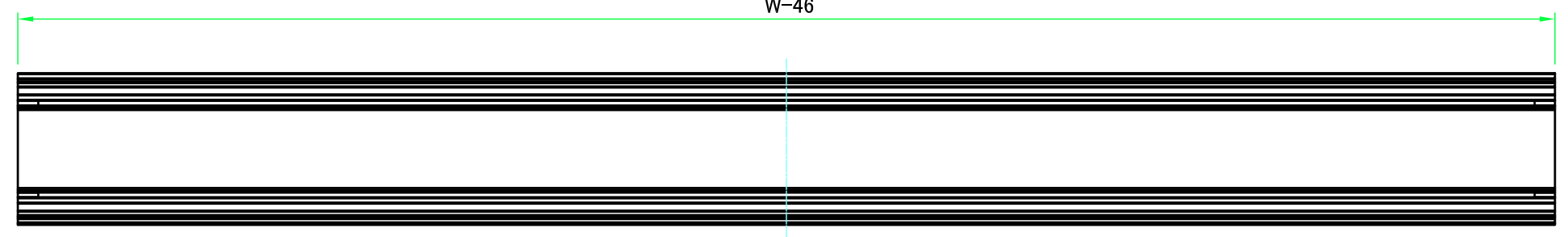

フレーム1 / Frame1

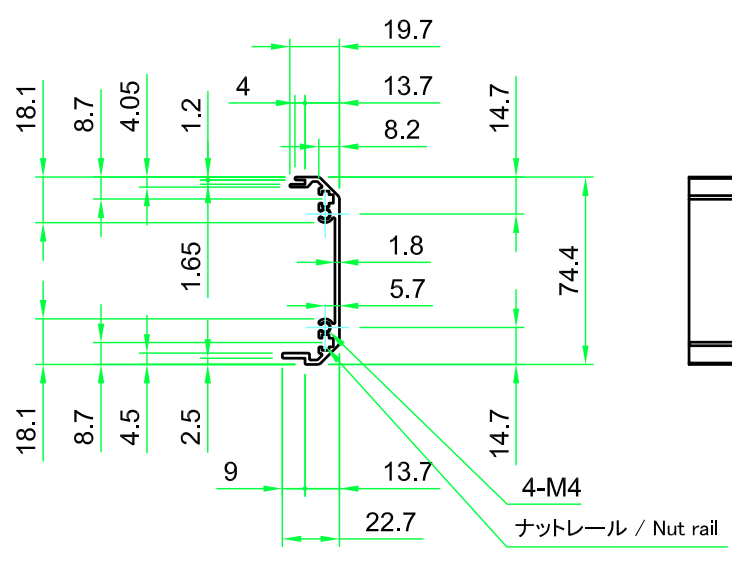
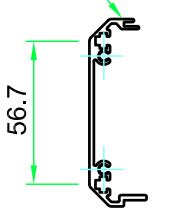

株式会社タカチ電機工業 TAKACHI ELECTRONICS ENCLOSURE CO., LTD.			品名/Title フレーム1 Frame1	尺度/Scale 1:3
承認/Approved	検図/Checked	製図/Created	型番/Product number H75.4 - W601 ~ 1000	
中根	野村	中根	作成日/Date 2019/12/23	3 / 7

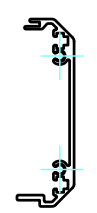
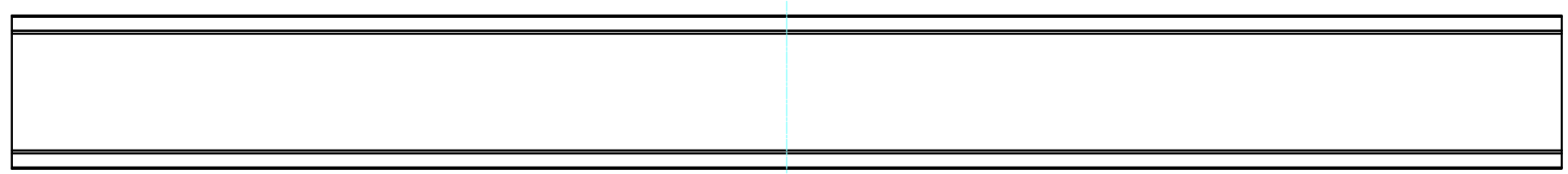
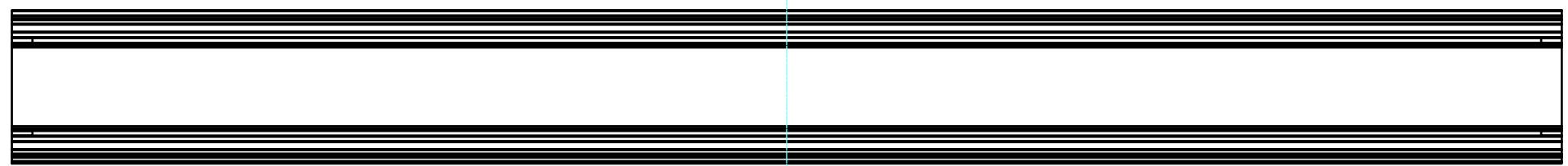

フレーム2 / Frame2

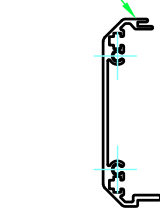

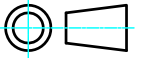
 株式会社タカチ電機工業 TAKACHI ELECTRONICS ENCLOSURE CO., LTD.			品名/Title フレーム2 Frame2	 尺度/Scale 1:3
承認/Approved	検図/Checked	製図/Created	型番/Product number H75.4 - W601 ~ 1000	
中根	野村	中根	作成日/Date 2019/12/23	4 / 7

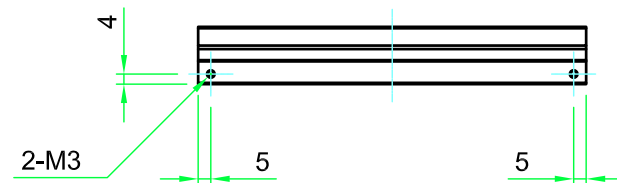
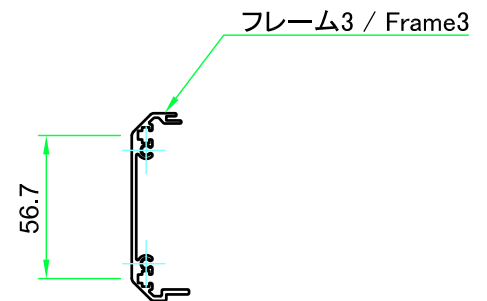
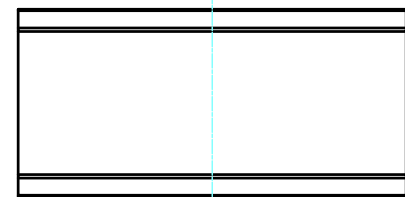
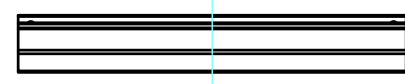
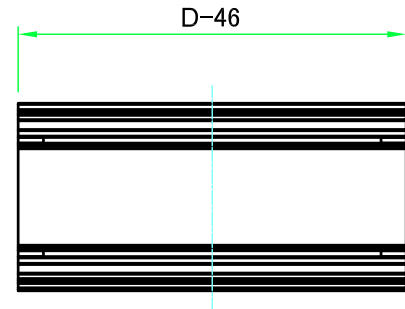
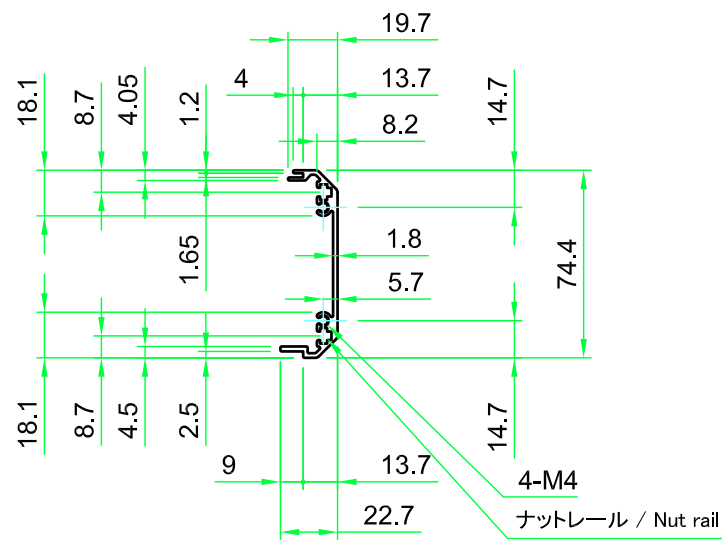

株式会社タカチ電機工業 TAKACHI ELECTRONICS ENCLOSURE CO., LTD.			品名/Title フレーム3 Frame3	尺度/Scale 1:3
承認/Approved	検図/Checked	製図/Created	型番/Product number H75.4 - D75~399	
中根	野村	中根	作成日/Date 2019/12/23	5 / 7

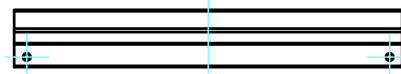
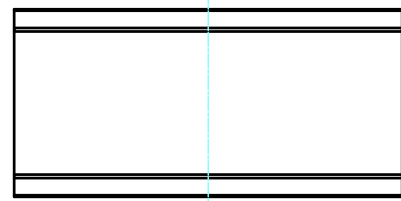

フレーム4 / Frame4

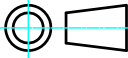
 株式会社タカチ電機工業 TAKACHI ELECTRONICS ENCLOSURE CO., LTD.			品名/Title フレーム4 Frame4	
承認/Approved 中根	検図/Checked 野村	製図/Created 中根	型番/Product number H75.4 - D75~399	尺度/Scale 1:3
			作成日/Date 2019/12/23	6 / 7

ハメ込みパネル / Slide panel

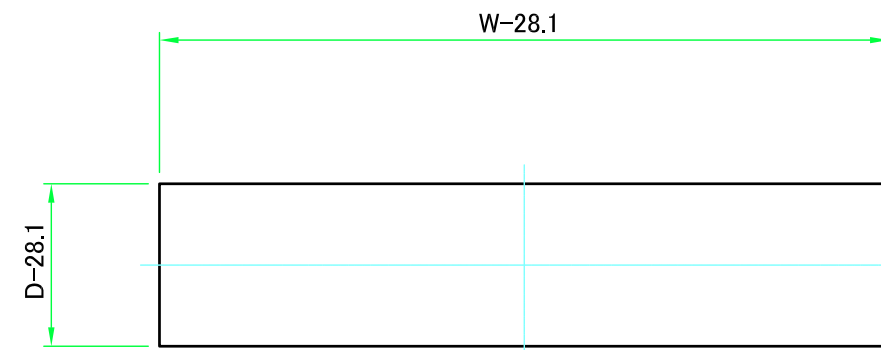
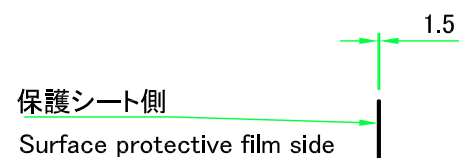
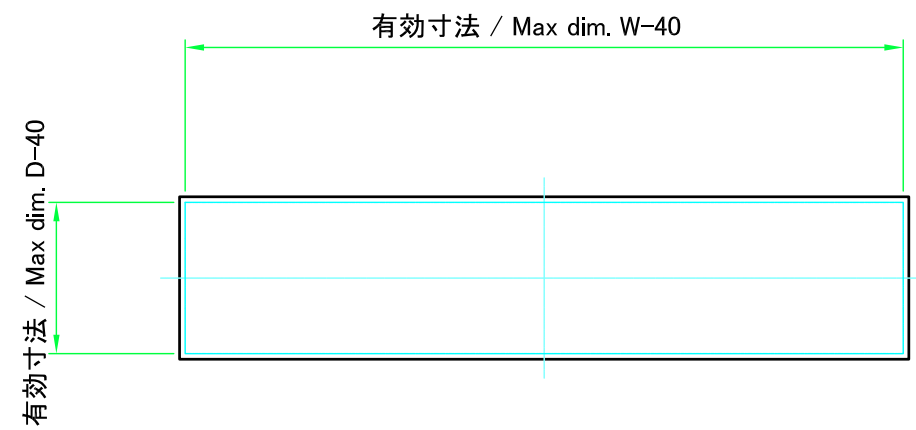

パネル表面 / Panel Frontside

パネル裏面 / Panel Backside

ねじ止めパネル / Screwed panel

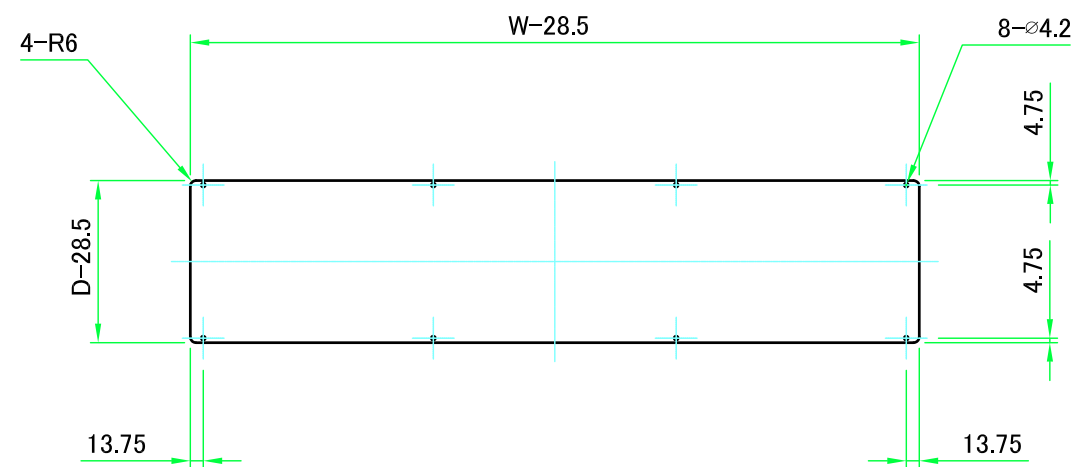
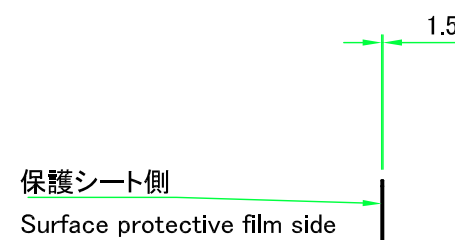
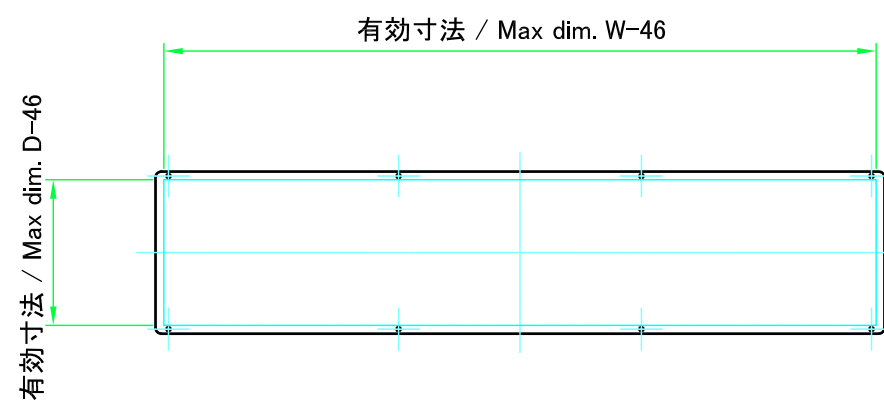

パネル表面 / Panel Frontside

パネル裏面 / Panel Backside

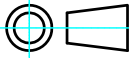
 株式会社タカチ電機工業 TAKACHI ELECTRONICS ENCLOSURE CO., LTD.			品名/Title パネル Panel	 尺度/Scale 1:8
承認/Approved	検図/Checked	製図/Created	型番/Product number W601~1000 - D75~399	
中根	野村	中根	作成日/Date 2019/12/23	7 / 7